

Midi free-standing Beacons / Flash Light 828
Flashing Beacon BM 12VDC RD



Part No.: 828.100.54



MECHANICAL DATA

Height	137 mm
Diameter	98 mm
Materials	PC PC/ABS
Dome colour	Red
Housing colour	Black
Protection category	IP65
Connection	Screw terminals
cross-sectional area maximum	2,50mm ² / 14AWG
Cable entry	Rubber pinch
Cable entry minimum	d = 5 mm
Cable entry maximum	d = 7 mm
Type of fixing	Base mounting
Working temperature minimum	-20°C
Working temperature maximum	+45°C
Weight with packaging	267 g
Product weight	223 g

ELECTRICAL DATA

Operating voltage	12V
Operating voltage type	DC
Operating voltage tolerance	+/- 10%
Rated operational voltage	12 VDC
Rated operational current	500 mA
Rated inrush current	12.000 mA
Protection class	Protection class 2
Pollution degree	3

OPTICAL DATA

Light source	Xenon
Light colour	Red
Optical signal image	Flash
Flash frequency	1 Hz
Flash output	5 J
Service life optical	4 million flashes minimum

APPROVAL DATA

Conforms with CE	Yes
WEEE	Yes



For additional installation and mounting information, refer to the appropriate user guide at www.werma.com. This printed copy is for information only and is subject to alteration.

Midi free-standing Beacons / Flash Light 828
Flashing Beacon BM 12VDC RD

Conform with ATEX-directive	No
Conforms with CCC	No
Conforms with UL	cULus
UL Type Rating	Type 12
Conforms with FCC	No
Conforms with IC	No
EAC certificate available	Yes
Conforms with AS-I	No
ICAO Certification	No
Conforms with GL	No
Conforms with RoHS CN	No
Conforms with VdS	No

DRAWING

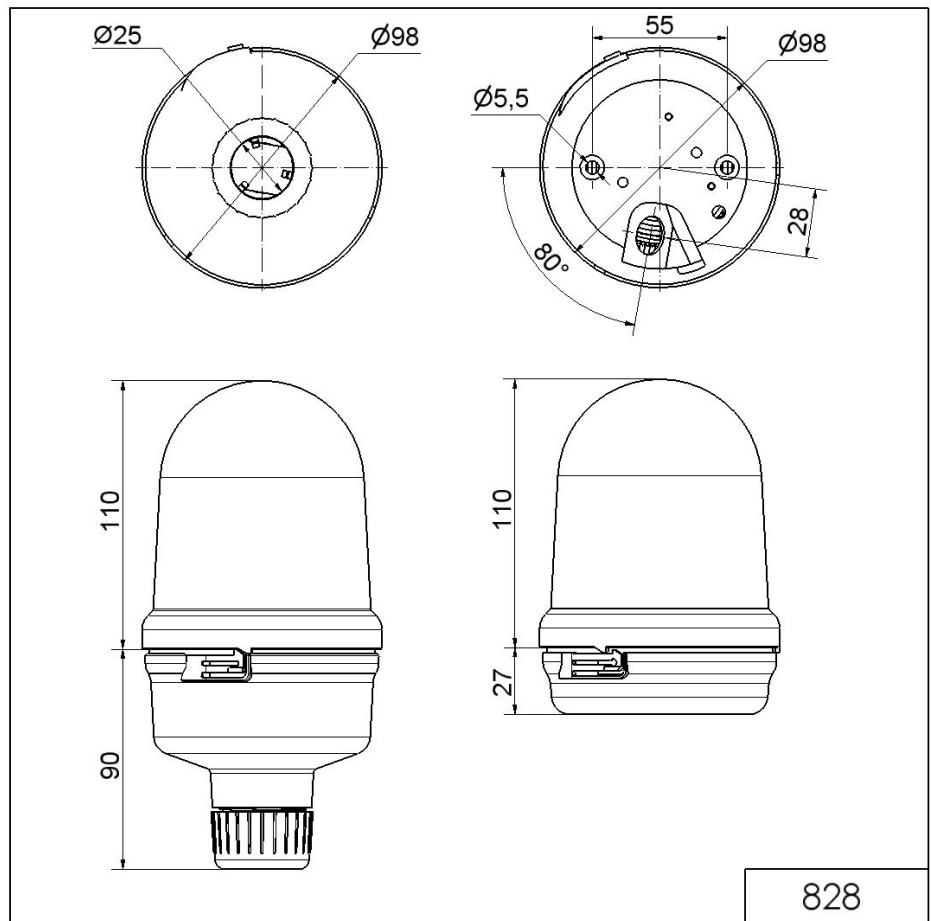

For additional installation and mounting information, refer to the appropriate user guide at www.werma.com. This printed copy is for information only and is subject to alteration.